

Article number: 0101071
 Description: Retaining ring A 54 DIN 471
 Spring steel
 Note: Fitted with ZGA pilers

Measures

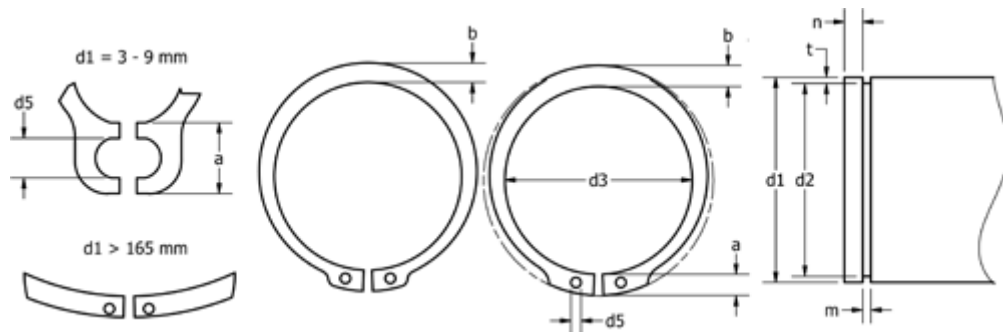

a max	= 7.1	FN kN	= 41.2	s	= 2.00
AN mm ²	= 247.0	FRg kN	= 11.30	t	= 1.50
b	= 5.3	FR kN	= 71.20	tol	= -0.30
d1	= 54	g	= 2.5	tol	= -0.07
d2	= 51.0	K kN-mm	= 129.00	tol	= +0,39-0,90
d3	= 49.8	m min	= 2.15	Tong	= ZGA-3
d5 min	= 2.5	n abl x 1000	= 9.0	Weight kg/1000	= 11.300
Description	= A54	Nominal drive	= 4.5		